

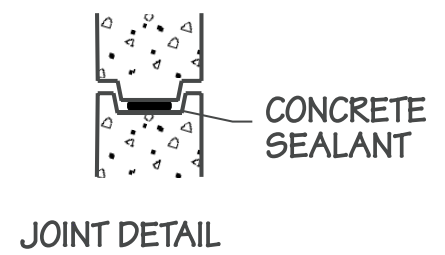

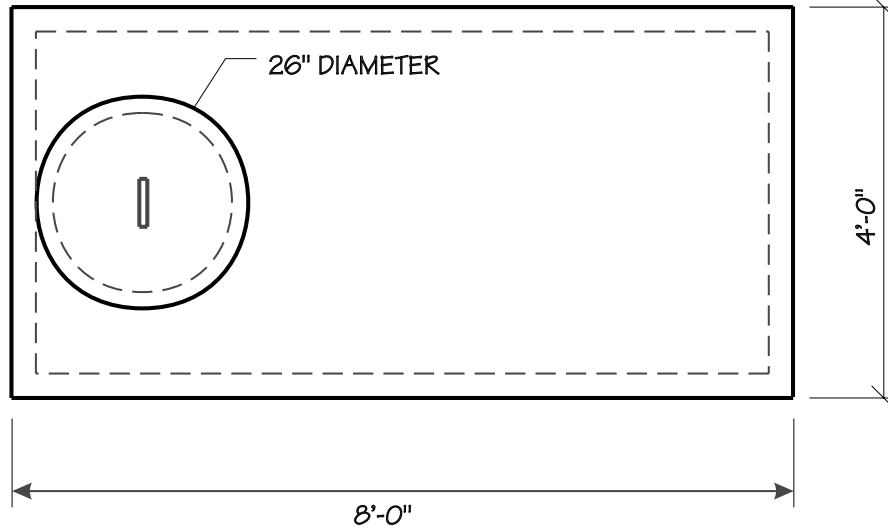

500 GALLON PUMP CHAMBER

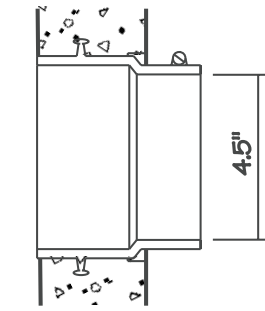
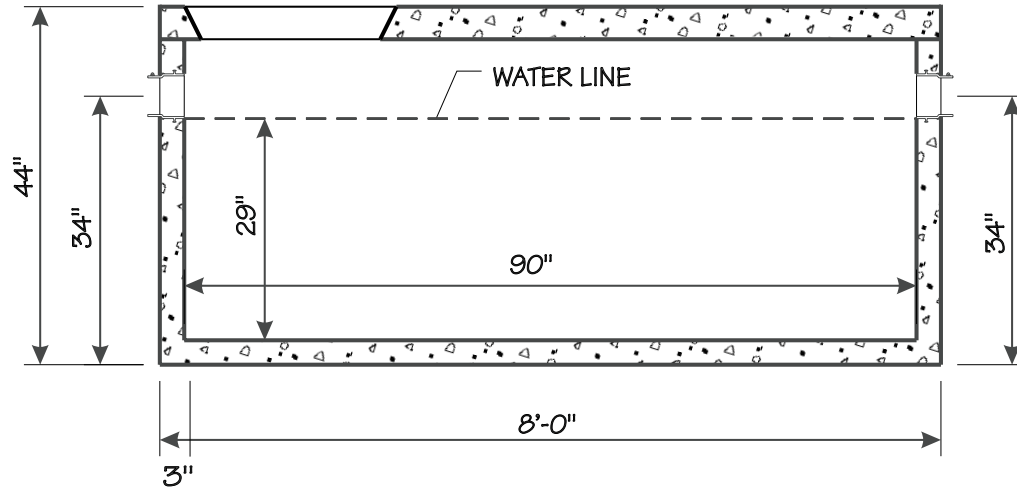

VOLUME - CAPACITY:	FABRICATION SPECS:
CAPACITY: 90" x 42" x 29" = 474 GAL.	TONGUE AND GROOVE JOINT, SEALED WITH 3/4" x 3/4" BUTYL SEALANT
GALLONS PER INCH = 16.36	REINFORCEMENT - 4" x 4" x 14/14 GALVANIZED WIRE FABRIC
	CONCRETE - 4000 PSI (AIR ENTRAINED)
OVERALL WEIGHT: 5020 LBS.	  



4944 Mason Road, Howell, MI 48843
 PH 517 546-2810 FAX 517 546-4480
www.americanconprod.com